

**INFORME TÉCNICO SOBRE LA
OPERACIÓN DEL RELLENO SANITARIO DE
QUITO
EMGIRS-EP**

MARZO 2013

1. INGRESO MENSUAL DE RESIDUOS SOLIDOS AL RELLENO SANITARIO DE EL INGA

MARZO 2013					
DIA	FECHA	DISTRITO (Ton)	RUMIÑAHUI (Ton)	HOSPITALARIOS (Ton)	TOTAL (Ton)
V	01/03/2013	1758,21	79,50	17,36	1855,07
S	02/03/2013	1836,49	83,77	0,00	1920,26
D	03/03/2013	826,6	92,91	0,00	919,07
L	04/03/2013	1520,82	92,11	1163	1624,56
M	05/03/2013	2.478,71	131,18	10,57	2.620,46
M	06/03/2013	1921,26	89,51	1129	2.022,06
J	07/03/2013	1619,35	79,41	9,14	1707,90
V	08/03/2013	1651,03	76,38	0,00	1727,41
S	09/03/2013	1838,48	83,80	0,00	1922,28
D	10/03/2013	718,65	90,30	0,00	808,95
L	11/03/2013	1607,74	118,60	18,09	1744,43
M	12/03/2013	2.454,31	115,01	12,55	2.581,87
M	13/03/2013	1880,63	92,44	15,66	1988,73
J	14/03/2013	1625,05	86,32	13,17	1724,54
V	15/03/2013	1717,87	98,30	10,36	1826,53
S	16/03/2013	1799,45	71,46	0,00	1870,91
D	17/03/2013	799,74	94,11	0,00	893,85
L	18/03/2013	1541,29	120,30	10,12	1671,71
M	19/03/2013	2.418,26	107,86	12,56	2.538,68
M	20/03/2013	1984,00	90,43	10,98	2.085,41
J	21/03/2013	1617,07	85,47	10,75	1713,29
V	22/03/2013	1809,97	107,21	0,00	1917,18
S	23/03/2013	1886,80	60,66	0,00	1947,46
D	24/03/2013	770,96	106,63	0,00	877,59
L	25/03/2013	1768,59	119,00	1148	1899,07
M	26/03/2013	2.412,41	108,55	10,04	2.531,00
M	27/03/2013	2.185,36	107,01	10,12	2.302,49
J	28/03/2013	1806,88	103,95	1138	1922,21
V	29/03/2013	1557,10	109,49	0,00	1666,59
S	30/03/2013	1528,76	54,32	0,00	1583,08
D	31/03/2013	719,90	111,45	0,00	831,35
TOTAL (Ton)		52.061,30	2.967,44	217,25	55.245,99
PROMEDIO (Ton)		1.679,40	95,72	7,01	1.782,13

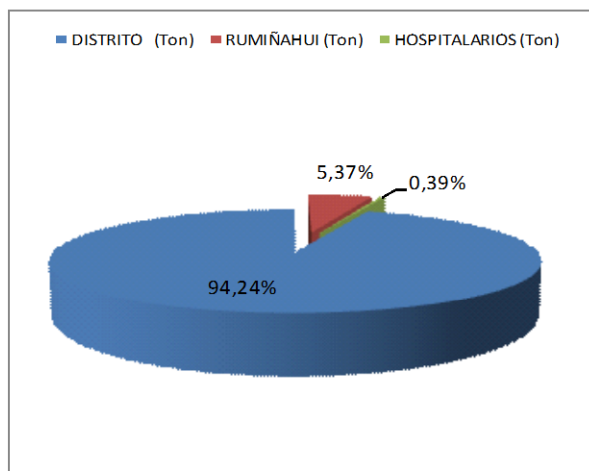
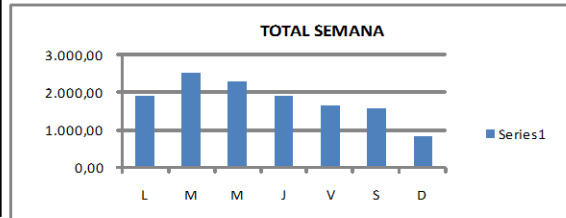
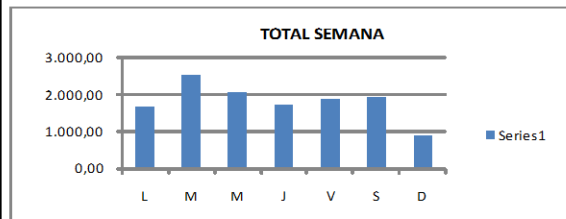
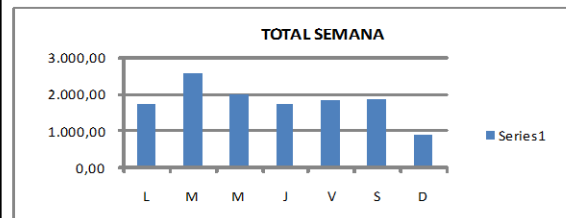
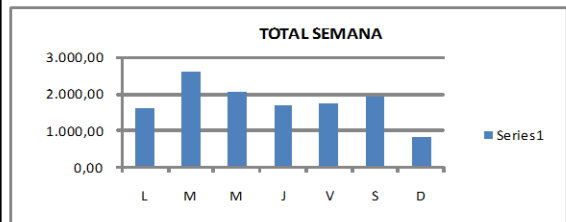
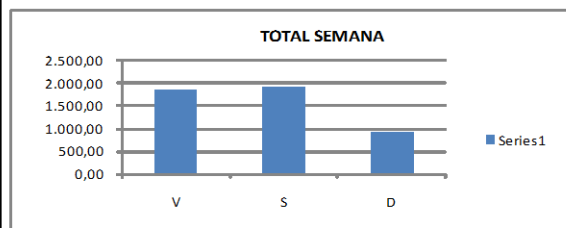

DIA	PROMEDIO
LUNES	1734,94
MARTES	2.399,02
MIERCOLES	2.004,12
JUEVES	1516,20
VIERNES	1798,56
SABADO	1848,80
DOMINGO	866,6

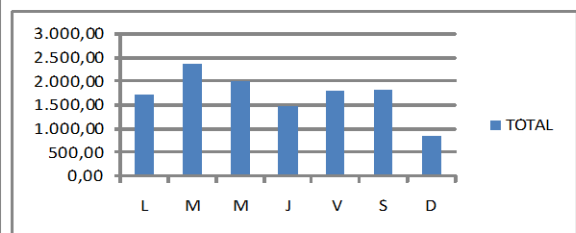

1.1 CONDENSADO MENSUAL

DISPOSICION RSU EN RELLENO SANITARIO - AÑO 2013				
MES	DISTRITO (Ton)	RUMIÑAHUI (Ton)	HOSPITALARIOS (Ton)	TOTAL (Ton)
Enero	54.761,43	3.238,91	230,29	58.230,63
Febrero	45.495,01	2.661,46	179,39	48.335,86
Marzo	52.061,30	2.967,44	217,25	55.245,99
Abril				
Mayo				
Junio				
Julio				
Agosto				
Septiembre				
Octubre				
Noviembre				
Diciembre				
TOTAL (Ton)	152.317,74	8.867,81	626,93	161.812,48
PROMEDIO (Ton)	50.772,58	2.955,94	208,98	53.937,49



2. ESTACIONES DE TRANSFERENCIA

ET NORTE

DIA	EMASEO (TON)	PARTICULARES (TON)	TRANSPORTADO (TON)	RECICLADO (TON)	TOTAL	
					INGRESADO (TON)	SALIDA (TON)
vie-01	1.006,55	31,31	921,42	18,60	1.037,86	940,02
sáb-02	1.082,86	4,20	1.013,42	14,86	1.087,06	1.028,28
dom-03	350,04	25,05	428,52	-	375,09	428,52
lun-04	1.075,09	9,14	826,21	23,14	1.084,23	849,35
mar-05	1.389,02	16,73	1.446,60	16,00	1.405,75	1.462,60
mié-06	1.008,30	9,39	948,88	30,13	1.017,69	979,01
jue-07	1.016,36	17,44	914,25	36,62	1.033,80	950,87
vie-08	952,81	24,24	964,43	30,15	977,05	994,58
sáb-09	1.133,98	12,00	985,81	9,46	1.145,98	995,27
dom-10	319,55	34,15	444,18	-	353,70	444,18
lun-11	1.059,34	12,09	886,28	28,29	1.071,43	914,57
mar-12	1.454,36	19,81	1.359,15	13,54	1.474,17	1.372,69
mié-13	926,59	8,08	999,42	18,32	934,67	1.017,74
jue-14	1.044,09	9,50	851,06	31,05	1.053,59	882,11
vie-15	946,59	22,73	953,39	11,84	969,32	965,23
sáb-16	1.082,36	15,03	1.022,07	5,27	1.097,39	1.027,34
dom-17	350,77	45,05	436,85	-	395,82	436,85
lun-18	1.050,40	8,01	890,23	12,23	1.058,41	902,46
mar-19	1.421,58	11,86	1.358,87	29,38	1.433,44	1.388,25
mié-20	1.051,95	11,62	1.016,13	27,83	1.063,57	1.043,96
jue-21	1.022,90	24,43	983,12	20,76	1.047,33	1.003,88
vie-22	1.013,08	19,10	921,04	25,09	1.032,18	946,13
sáb-23	1.139,73	4,79	1.080,61	9,25	1.144,52	1.089,86
dom-24	387,05	27,58	441,39	-	414,63	441,39
lun-25	1.114,19	17,60	974,06	37,87	1.131,79	1.011,93
mar-26	1.444,25	20,66	1.370,79	20,64	1.464,91	1.391,43
mié-27	1.112,03	18,63	1.035,68	17,39	1.130,66	1.053,07
jue-28	1.113,25	21,11	1.104,21	10,44	1.134,36	1.114,65
vie-29	790,55	5,73	814,09	-	796,28	814,09
sáb-30	889,94	8,84	804,53	6,23	898,78	810,76
dom-31	328,89	43,61	364,99	-	372,50	364,99
TOTAL	30.078,45	559,51	28.561,68	504,38	30.637,96	29.066,06

Fuente: Información proporcionada por Fiscalización de la EMGIRS-EP

ET SUR

DIA	EMASEO (TON)	PARTICULARES (TON)	TRANSPORTADO (TON)	TOTAL	
				INGRESADO (TON)	SALIDA (TON)
vie-01	679,29	8,29	733,19	687,58	733,19
sáb-02	764,57	2,80	729,01	767,37	729,01
dom-03	280,59	4,41	336,28	285,00	336,28
lun-04	739,07	-	691,01	739,07	691,01
mar-05	933,70	0,87	919,88	934,57	919,88
mié-06	767,50	6,13	769,44	773,63	769,44
jue-07	561,53	2,75	633,04	564,28	633,04
vie-08	725,37	4,18	674,77	729,55	674,77
sáb-09	681,82	2,33	728,65	684,15	728,65
dom-10	252,37	6,05	275,75	258,42	275,75
lun-11	750,10	4,05	692,36	754,15	692,36
mar-12	989,02	6,06	977,55	995,08	977,55
mié-13	760,77	13,02	781,23	773,79	781,23
jue-14	623,72	3,41	623,84	627,13	623,84
vie-15	687,83	8,52	700,52	696,35	700,52
sáb-16	691,07	6,80	760,21	697,87	760,21
dom-17	264,18	5,36	273,56	269,54	273,56
lun-18	694,66	-	636,19	694,66	636,19
mar-19	979,45	6,65	959,17	986,10	959,17
mié-20	825,75	4,28	866,24	830,03	866,24
jue-21	585,60	1,47	603,74	587,07	603,74
vie-22	727,40	6,30	706,65	733,70	706,65
sáb-23	822,07	11,36	755,68	833,43	755,68
dom-24	242,60	5,65	239,19	248,25	239,19
lun-25	725,27	-	819,25	725,27	819,25
mar-26	1.058,30	5,21	970,27	1.063,51	970,27
mié-27	827,50	28,07	854,45	855,57	854,45
jue-28	687,23	4,41	779,09	691,64	779,09
vie-29	588,25	8,10	606,65	596,35	606,65
sáb-30	666,83	-	629,50	666,83	629,50
dom-31	285,26	3,26	292,29	288,52	292,29
TOTAL	20.868,67	169,79	21.018,65	21.038,46	21.018,65

Fuente: Información proporcionada por Fiscalización de la EMGIRS-EP

3. VOLUMEN DIARIO/ MENSUAL DE LIXIVIADO EXTRAÍDO Y TRATADO.

Marzo 2013

RESUMEN DE VOLUMENES DE LAS PISCINAS Y VOLUMENES TRATADOS

FECHA	VOLUMENES ACUMULADOS	VOLUMEN INGRESADO	VOLUMEN TRATADO MBR	VOLUMEN TRATADO VSEP	VOLUMEN ACUMULADO
01/03/2013	84.626,01	395,30	116,23	221,83	57,24
02/03/2013	84.626,09	398,96	113,53	55,62	229,81
03/03/2013	84.622,80	422,30	25,01	111,51	285,78
04/03/2013	84.566,79	410,20	55,01	206,50	148,69
05/03/2013	84.496,98	397,15	94,43	185,76	116,96
06/03/2013	84.279,01	372,40	100,19	128,25	143,96
07/03/2013	84.076,27	356,52	50,00	152,19	154,33
08/03/2013	83.924,58	367,72	82,94	208,44	76,34
09/03/2013	83.769,49	377,28	103,59	52,38	221,31
10/03/2013	83.739,57	371,22	65,90	105,84	199,48
11/03/2013	83.709,70	370,55	78,86	211,25	80,44
12/03/2013	83.243,31	351,20	63,22	168,26	119,72
13/03/2013	83.272,85	454,17	66,01	127,01	261,15
14/03/2013	83.379,19	455,66	42,79	179,28	233,59
15/03/2013	83.478,96	493,32	105,59	182,52	205,21
16/03/2013	83.564,53	479,70	82,38	44,82	352,50
17/03/2013	83.466,46	350,39	30,24	0,00	320,15
18/03/2013	83.345,16	349,80	110,28	74,70	164,82
19/03/2013	83.378,12	479,37	100,33	74,70	304,34
20/03/2013	83.338,85	353,90	69,84	75,60	208,46
21/03/2013	83.087,73	445,69	71,02	77,58	297,09
22/03/2013	83.007,97	397,10	86,25	75,51	235,34
23/03/2013	83.006,24	419,36	25,16	0,00	394,20
24/03/2013	83.029,51	378,91	0,00	0,00	378,91
25/03/2013	83.090,86	522,22	36,31	76,32	409,59
26/03/2013	83.069,08	430,05	31,70	77,13	321,22
27/03/2013	83.043,66	433,57	32,65	74,25	326,67
28/03/2013	83.002,60	438,83	50,67	71,82	316,34
29/03/2013	82.958,31	420,33	52,10	0,00	368,23
30/03/2013	82.955,69	430,66	52,09	0,00	378,57
31/03/2013	83.010,09	410,98	0,00	0,00	410,98
PROMEDIO	83.553,76	410,80	64,33	97,39	249,08

4. FLUJOGRAMA DE LIXIVIADOS 28-Marzo 2013

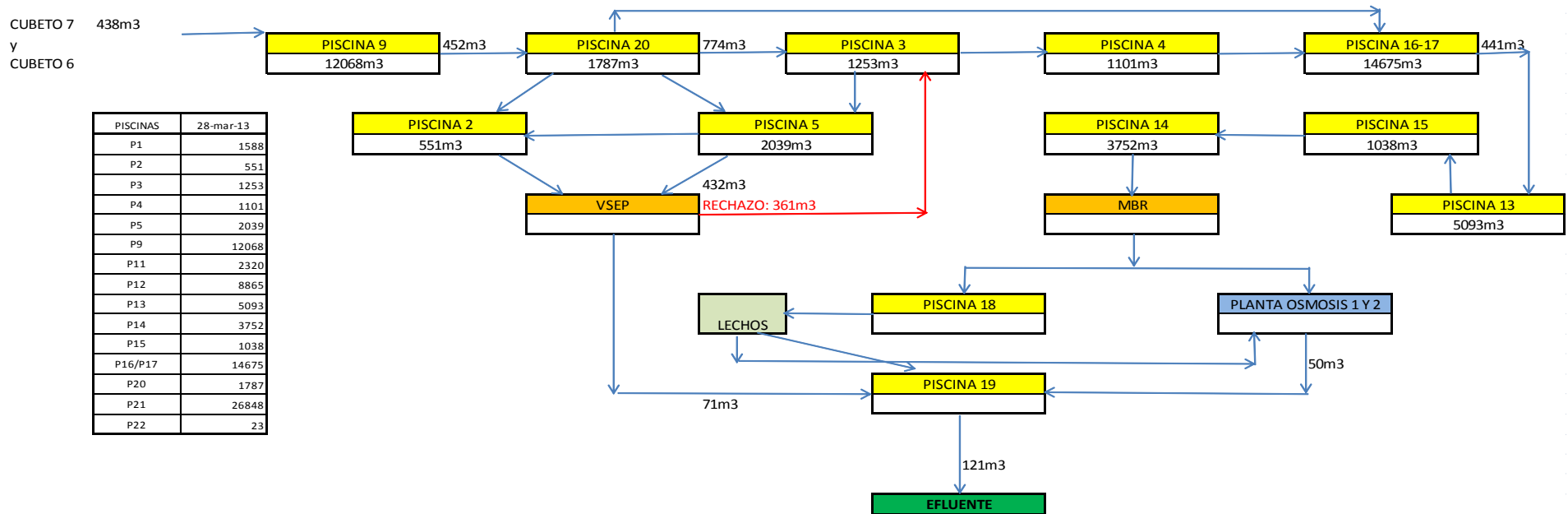

5. VOLUMEN ALMACENADO EN CADA UNA DE LAS PISCINAS, TOTAL AL FIN DEL PERÍODO REPORTADO.

Volumenes de Lixiviado en metros cúbicos (m3) almacenados en piscinas			
Piscina	Volumen a cota de desborde (m3)	Volumen a cota de seguridad (m3)	VOLUMENES DE LIXIVIADOS (m3)
			MARZO
P1	1.698,76	1.235,17	1.493,17
P2	816,86	688,23	664,12
P3	1.284,23	742,99	1.217,97
P4	1.154,77	974,17	1.069,13
P5	2.150,35	1.899,38	1.949,27
P9	23.459,23	22.905,73	9.210,15
P11	2.615,75	2.344,35	2.433,99
P12	9.132,00	8.294,77	8.673,62
P13	5.750,98	5.215,48	5.442,53
P14	3.979,95	3.781,47	3.661,77
P15	1.127,23	1.008,42	1.073,04
P16/P17	15.985,68	13.888,91	15.468,01
P20	2.995,64	2.710,72	1.610,61
P21	30.162,11	27.912,89	27.806,82
P22	5.069,57	4.731,95	1.779,56
TOTALES	107.383,12	98.334,63	83.553,76

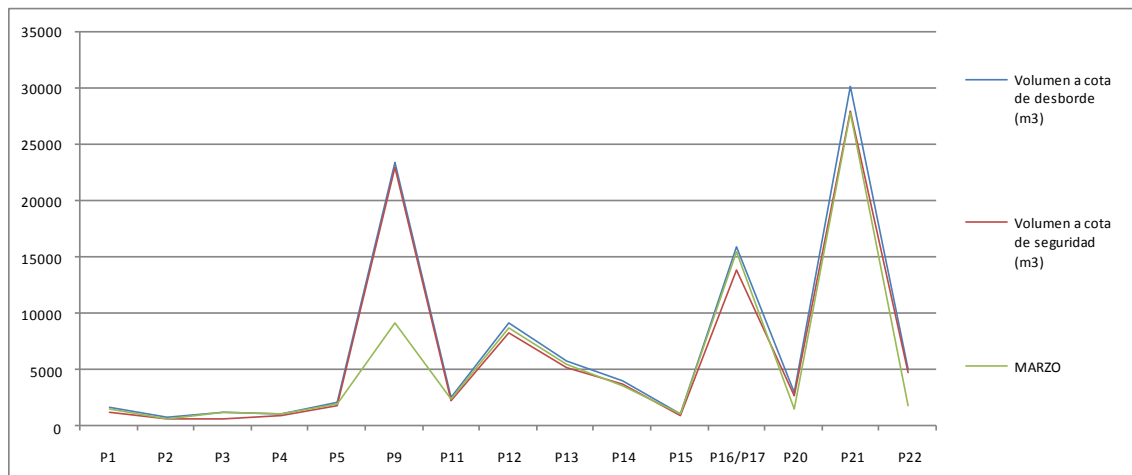
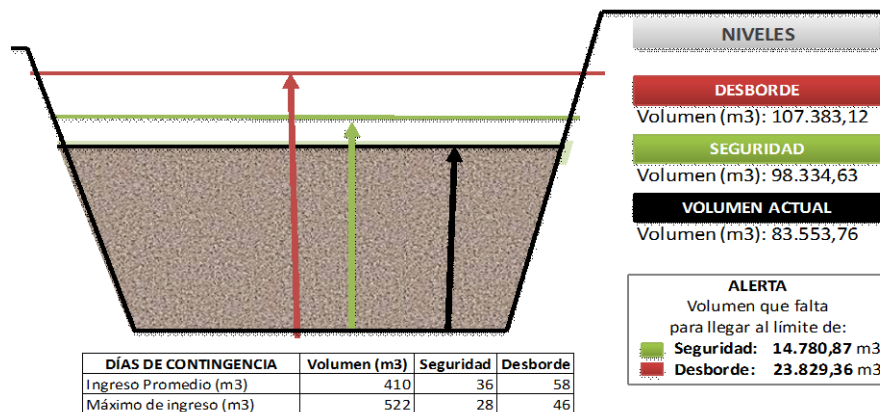

6. CARACTERÍSTICAS FÍSICO – QUÍMICAS DEL LIXIVIADO EN CADA UNA DE LAS PISCINAS Marzo 2013

LEYENDA	PISCINAS	DQO, mg/L	DBO, mg/L
1	9 IN	83266	35150
2	9 OUT	15629	4240
3	20	13822	9000
4	3	10989	4300
5	4	6437	1824
6	16-17	4861	1056
7	5	2,908	1642
8	VSEP IN	4500	10400
9	VSEP OUT	12	4

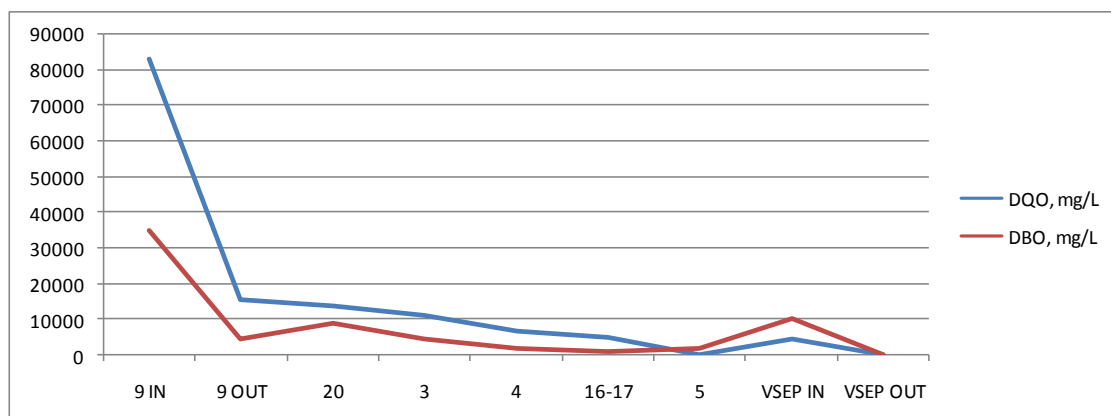

PISCINAS	CONDUCT, us
9	45000
20	40000
16-17	30200
VSEP IN	23000
VSEP OUT	250

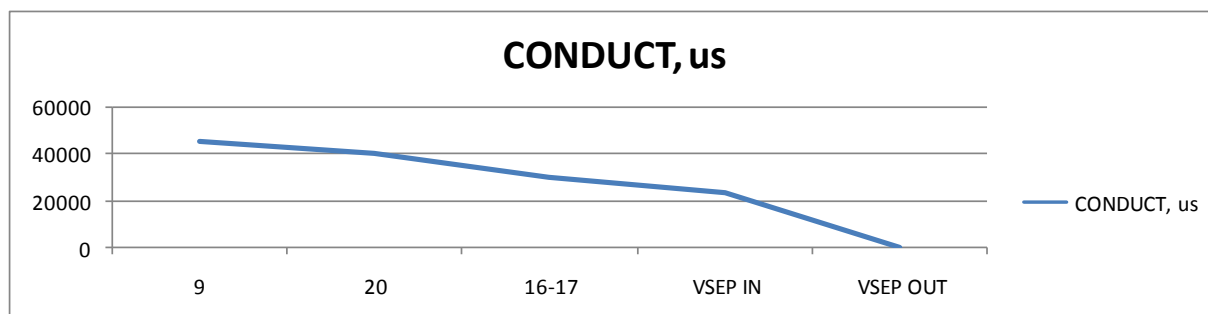

7. TRATAMIENTO DE RESIDUOS HOSPITALARIOS

Marzo 2013

CALENDARIO MARZO 2013		PESO EN KILOS		USUARIOS RECOLECTADOS
		CARGA INGRESADA	CARGA TRATADA	
		REGISTRO DE BASCULA R.S.	DISP. FINAL R.S REGISTRO DE BASCULA	
V	1	9.570,00	17.360,00	102
S	2	0,00	0,00	0
D	3	0,00	0,00	0
L	4	14.435,50	11.630,00	76
M	5	10.570,00	10.570,00	128
M	6	10.180,00	11.290,00	120
J	7	8.430,00	9.140,00	125
V	8	8.830,00	0,00	94
S	9	0,00	0,00	0
D	10	0,00	0,00	0
L	11	14.150,00	18.090,00	74
M	12	11.100,00	12.550,00	126
M	13	10.710,00	15.660,00	56
J	14	8.470,00	13.170,00	121
V	15	10.130,00	10.360,00	94
S	16	0,00	0,00	0
D	17	0,00	0,00	0
L	18	14.150,00	10.120,00	55
M	19	10.260,00	12.560,00	106
M	20	9.810,00	10.980,00	99
J	21	8.920,00	10.750,00	84
V	22	5.500,00	0,00	42
S	23	0,00	0,00	0
D	24	0,00	0,00	0
L	25	13.210,00	11.480,00	0
M	26	10.200,00	10.040,00	0
M	27	11.250,00	10.120,00	0
J	28	6.860,00	11.380,00	0
V	29	1.070,00	0,00	0
S	30	0,00	0,00	0
D	31	0,00	0,00	0
TOTAL MES		207.805,50	217.250,00	1.502

FUENTE: Planta de Tratamiento de Desechos Hospitalarios